

Kinghelm®

型号: KH-MICRO-SMT.LF-5P

版次	工程变更号	变更内容	变更日期	变更人员
A	—	图纸新设计	2014/11/18	PSJ

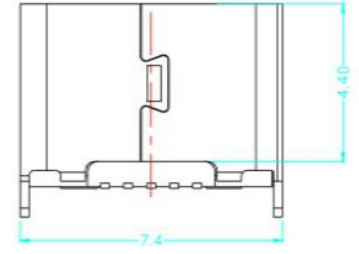
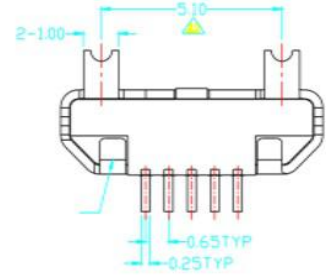
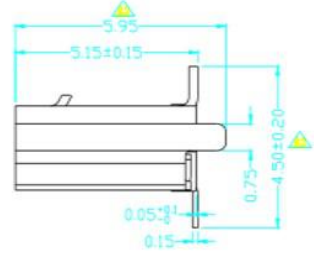
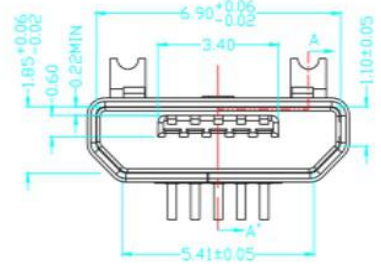
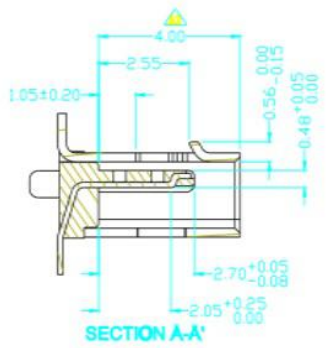
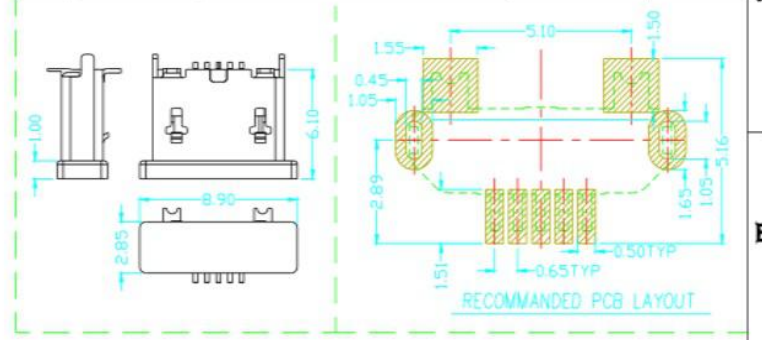
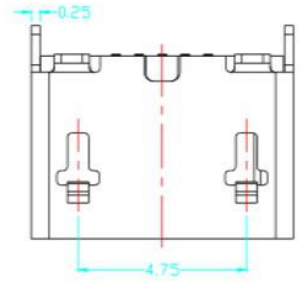

深圳市金航标电子有限公司				WWW.BDS666.COM			
型号: KH-MICRO-SMT.LF-5P				0755-83044319			
未标注公差值:	品名规格	MICRO USB 5PIN 贴板式B款母座					
.0=±0.25	料号			图号			
.00=±0.15	页面	1/1	比率	1:1	单位	mm	纸张
.000=±0.05	角度: ±1°						A4
	批准		审核		绘图		版本
							A