

Kinghelm®

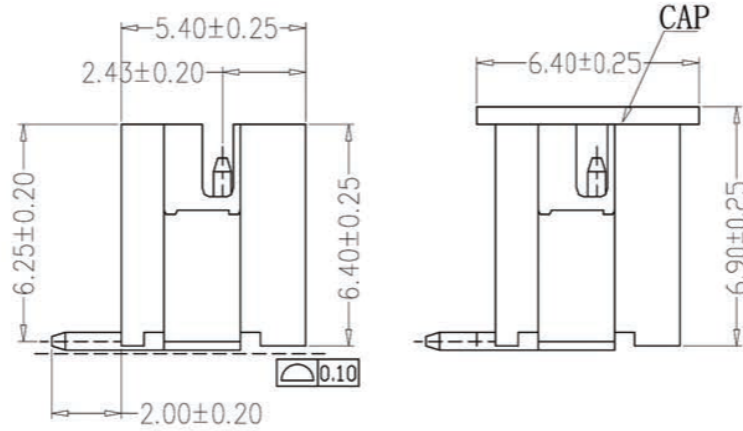

SPECIFICATIONS

- 1、Current Rating: 2A AC, DC
- 2、Voltage Rating: 250V AC, DC
- 3、Temperatuer Range: $-25^{\circ}\text{C} \sim +85^{\circ}\text{C}$
- 4、Contact Resistance: $20\text{m}\Omega$ Max
- 5、Insulation Resistance: $1000\text{M}\Omega$ Min
- 6、Withstanding Voltang: 800V AC/minute
- 7、Material: Wafer Nylon 6T, UL94V-0
PIN Brass Tin-plated
Solder tad Phosphoric bronze Tin-plated

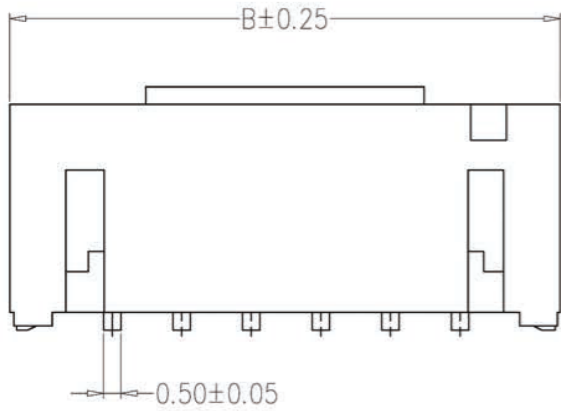
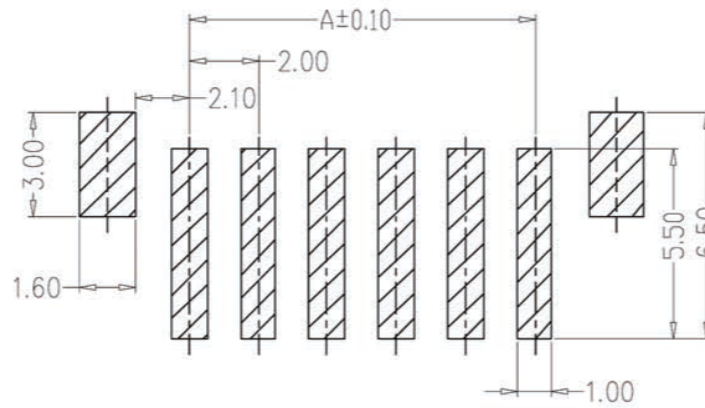
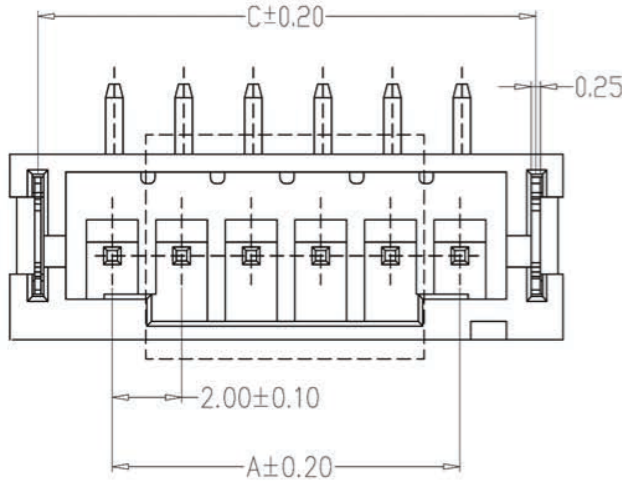

PCB LAYOUT

编号	尺寸 (mm)		
	A	B	C
A2001LF-02A	2.00	8.00	6.50
A2001LF-03A	4.00	10.00	8.50
A2001LF-04A	6.00	12.00	10.50
A2001LF-05A	8.00	14.00	12.50
A2001LF-06A	10.00	16.00	14.50
A2001LF-07A	12.00	18.00	16.50
A2001LF-08A	14.00	20.00	18.50
A2001LF-09A	16.00	22.00	20.50
A2001LF-10A	18.00	24.00	22.50
A2001LF-11A	20.00	26.00	24.50
A2001LF-12A	22.00	28.00	26.50
A2001LF-16A	30.00	36.00	34.50

贺骏驹
赖积任
张松强

制图 DRAWN	变更内容 DESCRIPTION	日期 DATE	GENERAL TOLERANCE		制图 DRAWING	贺骏驹	料号 PART NO.	A2001LF-NA		版本 REV.	A
			X.±0.25	X.±2'				品名 TITLE	PH立贴 WAFER SMT TYPE		
			.X±0.20	.X'±1'	审核 CHECK	赖积任	客户料号 CUTM. NO.				
			.XX±0.15	.XX'±0.5'	核准 APPROVAL	张松强	深圳市金航标电子有限公司		WWW.BDS666.COM		
			.XXX±0.10	.XXX'±0.5'	单位 UNITS	MM	比例 SCALE	1:1	KH-A2001LF-5A	0755-83044319	